

TECHNICAL DATASHEET



Humidity / Temperature transmitter with large electroluminescent display
THA 300

- Ranges from 0-100%RH and -40 to +180°C (probe dependent)
- Configurable intermediate ranges
- Functions : relative and absolute humidity, dew point, wet and dry temperature, enthalpy.
- Smart-Pro interchangeable probes (PC or stainless steel)
- On-site calibration
- Simultaneous display of 1 to 4 parameters
- KIMO external transmitter inputs (Class 200 and 300)
- 2 analogue outputs 4-20 mA (4 wires) or 0-10 V, RS 232, 4 6A/230 Vac RCR relays (for Ref. CPA300)
- 2 6A/230 Vac RCR relays (for Ref. CPA300HV)
- Audible alarms (buzzer - 80 dB)
- Output diagnostics
- MODBUS network RS 485 system (optional)
- Multi-directional housing made of ABS V-0 as per UL 94
- Large display (50 x 190 mm)

Transmitter features

Humidity

- Measuring range 0 to 100 %RH
- Units of measurement %RH
- Accuracy * (GAL) ± 2,58 % RH between 18°C and 28°C
- Response time <10 sec. (from 10%RH to 80%RH, V_{air} = 2 m/s)
- Resolution 0,1 %RH
- Type of sensor capacitive
- Type of fluid air et neutral gases (high resistance to solvents)

Temperature

- Measuring range from -20 to +120°C (Polycarbonate probe)
..... from -40 to +180°C (st. steel probe)
- Units of measurement °C, °F
- Accuracy * ± 0,5% of reading ± 0,3°C
- Response time t_{0.9} = 9 sec. for V_{air} = 1 m/s
- Resolution 0,1°C
- Type of sensor Pt 100 class A as per DIN IEC751
- Type of fluid air et neutral gases

* All accuracies indicated in this technical datasheet were stated in laboratory conditions, and can be guaranteed for measurements carried out in the same conditions, or carried out with calibration compensation.

HYGROMETRY PROBE :

Guaranteed Accuracy Limits* (GAL) = ±2,58%RH between 18 and 28°C (normal measurement range)

Measuring range : 3 to 98%RH
Short-term drift : 1%RH / year

* As per norm NFX 15-113 and the Charter "2000-2001 HYGROMETERS".

* GAL = Et + Ehl + k (uef²+ur²+ud²+us²)/2

As per the Charter 2000/2001 Hygrometers with :
Ehl : linearity and hysteresis errors = ± 1,19%RH
Et : temperature coefficient error = ± 0,31%RH
with : uet : uncertainty of calibration = ± 0,51%RH
ur : uncertainty of resolution = ± 0,003%RH
ud : manufacturing dispersion = ± 0,15%RH
us : comparison repeatability = 0,1%RH
k : coverage factor value = 2

Functions

THA 300 has 2 analogue outputs which corresponds to the 2 parameters displayed. You can activate 1 or 2 outputs and for each output, you can choose between humidity, temperature and the functions below :

Features / Functions	Measuring range	Units and resolutions
Absolute humidity	from 2 to 900 g/Kg	0,1 g/kg
Dew point	from -80 to +180°C	0,1°C - 0,1°F
Humid temperature	from -20 to +180°C	0,1°C - 0,1°F
Enthalpy	from 0 to 15 000 KJ/Kg	0,1 KJ/Kg

THA 300 can display 4 parameters alternatively. The 2 last parameters are only dedicated to display and they have no output.

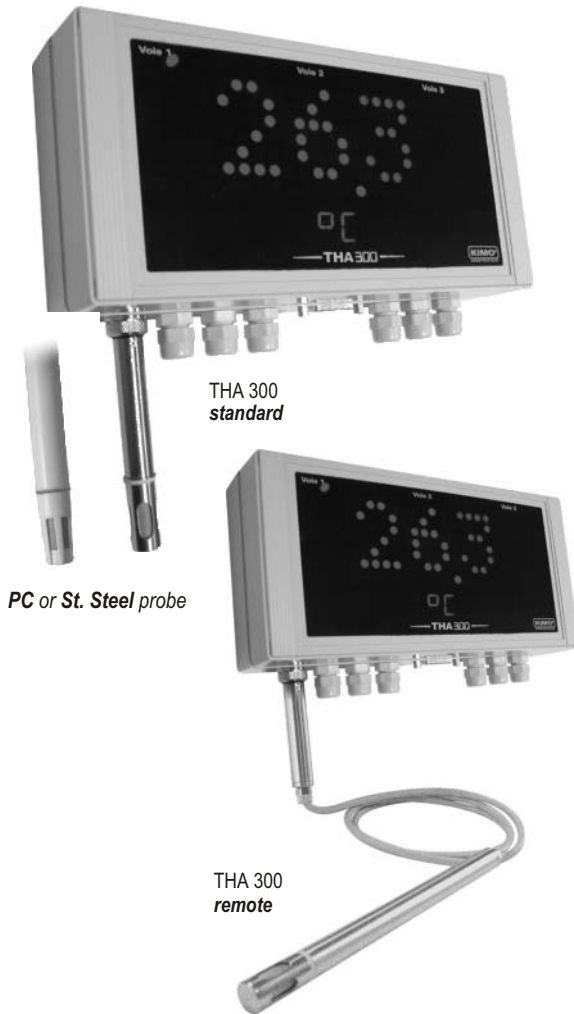

Part number

To order, just add the codes to complete the part number.

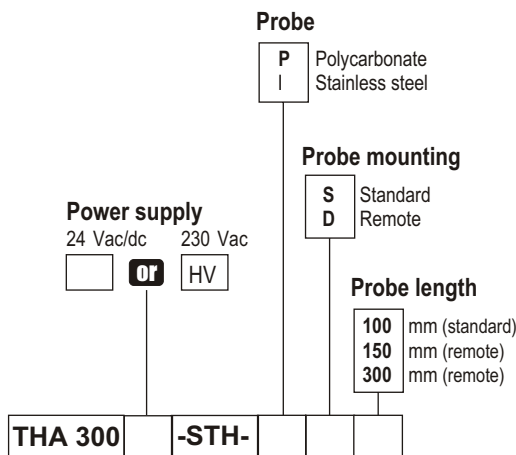

Example : THA 300 HV -STH- P S 100
Humidity and temperature transmitter with power supply 230 Vac. The probe is in polycarbonate, 100mm length and it is mounted in standard.



• Easy maintenance with the new SMART PRO digital probes.

• **Totally interchangeable** : they are individually adjusted and are automatically recognized by the transmitter.

Housing dimensions

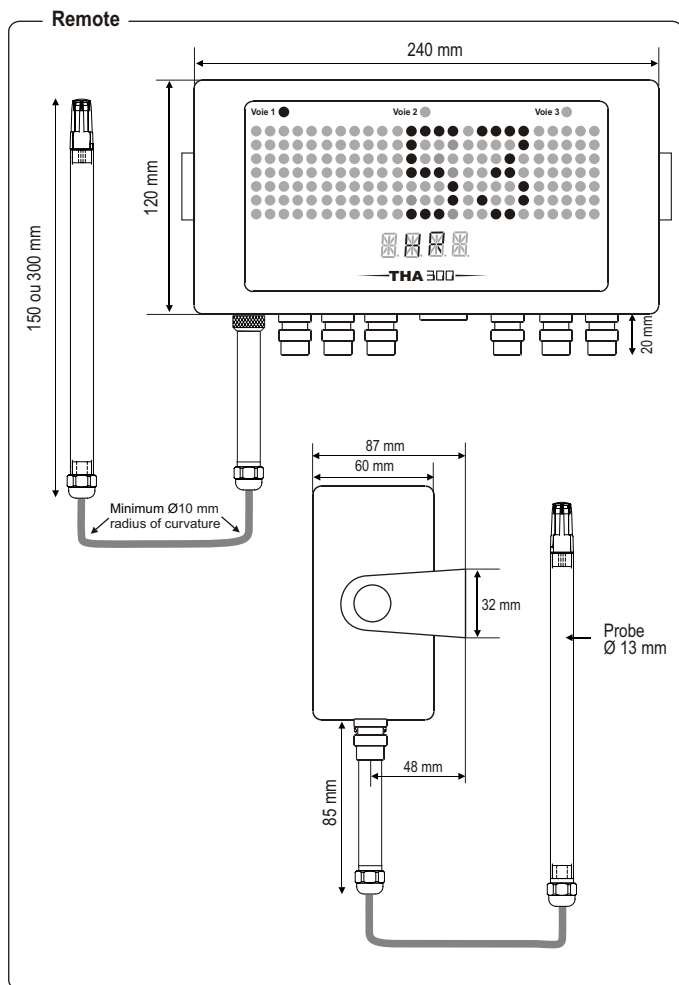
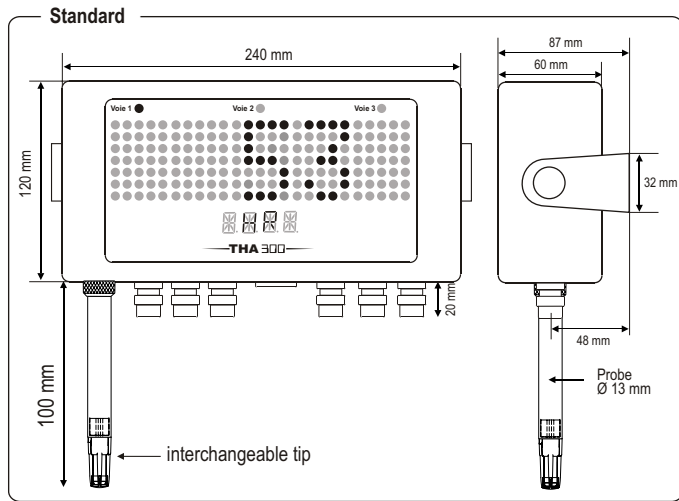

Housing features

HousingABS, multi directional (30°)
ProtectionIP 63
Fire-proof classificationV-0 as per UL 94
Dimensionssee drawing
Connection fittingPolyamide for 7 mm max cable
Weight1000 g

Probes features

White Polycarbonate probes

Measuring range-20 to +120°C
Standard probeLength 100 mm
Remote probeLength 150 or 300 mm (others on request)
CablePVC Ø 4,8 mm, lg 2 m (others on request)

Polycarbonate probes are supplied with a flow-through polycarbonate protection tip with stainless steel filter 25 (ref.EPP2).

Stainless steel 316 L

Measuring range-40 to +180°C
Standard probeLength 100 mm
Remote probeLength 150 or 300 mm (others on request)
Cablesilicone Ø 4,8 mm, lg 2 m (others on request)

Stainless steel probes are supplied with flow-through stainless protection tip with stainless steel filter 25 (ref.EPI25).

Tip selection

Tip materialPC⁽¹⁾, St.Steel⁽²⁾ or PTFE⁽³⁾
Filter materialSt.Steel or PTFE
Filter typeMeshed or sintered

(1) PC : White Polycarbonate - (2) PTFE : White Teflon® - (3) St.Steel : 316 L

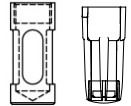

Display features

Displayelectroluminescent alphanumeric (75 x 190 mm)
 protection screen made of inactive red PMMA
1st line (measurement)...5 digits (dot matrix 5 x 7) 50 x 190 mm
2nd line (unit).....4 digits (14 segments) 13 x 45 mm
Number of channels.....from 1 to 4 channels, alternatively (3 seconds)
Location of channelswith 3 red identified LED
Response time.....< 1 sec.

Technical specifications

Power supply24 Vac/Vdc ± 10%
 230 Vac ± 10%, 50-60 Hz
Output2 x 4-20 mA or 2 x 0-10 V (4 wires)
 maximum load : 500 Ohms (4-20 mA)
 minimum load : 1 K Ohms (0-10 V)
Galvanic isolationon the outputs
Consumption5 VA
Relaysfor Ref. THA300 :
 4 6A/230 Vac RCR relays
 for Ref. THA300 HV :
 2 6A/230 Vac RCR relays
Audible alarmsbuzzer (80 dB)
Electro-magnetical compatibility ...EN 61 326
Electrical connectionscrew terminal blocks for cables
 Ø 1.5 mm² max
RS485 communicationdigital : RTU protocol Modbus
 communication speed configurable
 from 2400 to 115200 Bauds
RS232 communicationdigital : ASCII, proprietary protocol
Working temperature0 to +50°C
Storage temperature-10 to +70°C
Environmentair and neutral gases

Relays and Alarms

THA 300 has 4 stand-alone and configuration alarms :
 4 RCR relays (contacts).

THA 300 HV has 2 stand-alone and configuration alarms :
 2 RCR relays (contacts).

Settings available :

- selection of parameters (pressure, air velocity, temperature...)
- 1 or 2 setpoints (up & down) per alarm
- time-delay period from 0 to 60 sec
- action type : rising or falling action
- relay mode : negative or positive security
- audible alarm activation (buzzer)

Connection

- a. Analogue outputs
- b. Relays 1 and 2
- c. RS 485 connection
- d. Relays 3 and 4
- e. Power supply
- f. RS 232 connector
- g. Connection fittings
- h. Connector for Smart Pro hygrometry probe
- i. Output selection 4-20 mA or 0-10V

THA 300 type

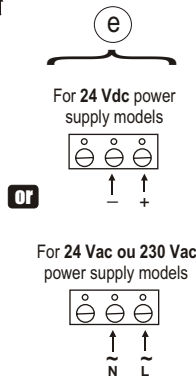
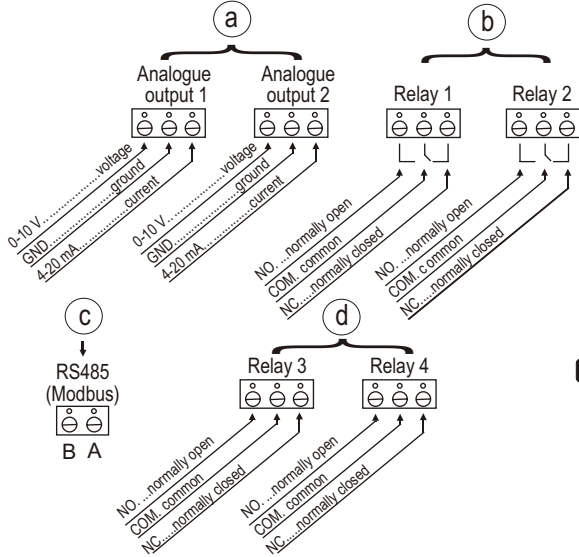
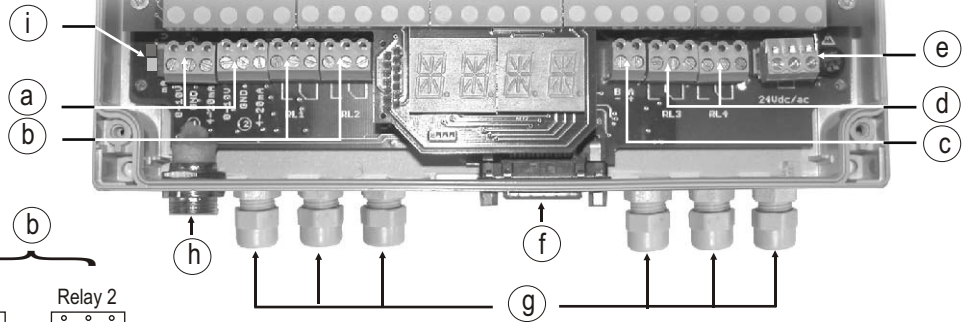

THA 300 HV type

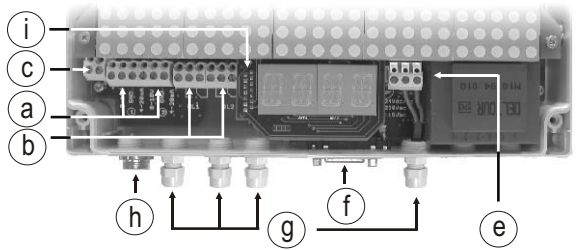

Electrical connections - as per NFC15-100 norm

⚠ This connection must be made by a qualified technician. Whilst making the connection, the transmitter must not be energized. Before making the connection, you must first check the power supply which is indicated on the transmitter board (see ① on the connection drawing)

Power supply connection :

- For 24 Vdc power supply models :

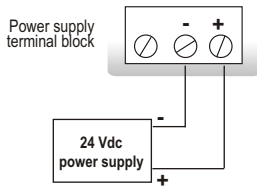

- For 24 Vac power supply models :

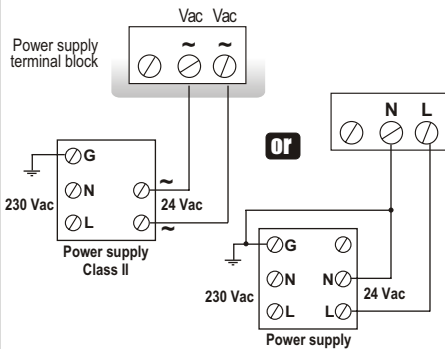

- For 230 Vac power supply models :

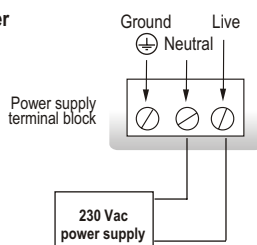

Output signal selection voltage (0-10 V) or current (4-20 mA)

The switch located on the left top of the transmitter (see ① on connection drawing) allows to select one of the 2 outputs.

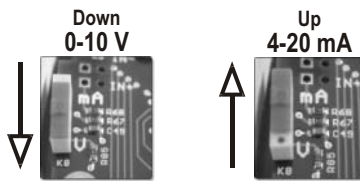

Output connection :

- 4-20 mA current output :

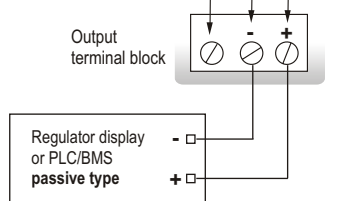

- 0-10 V voltage output :

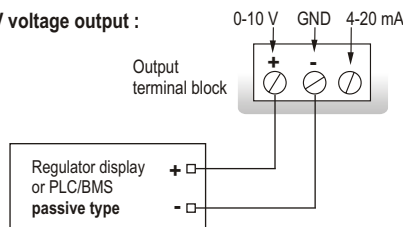

Connection of SUB-D15 RS 232 and RS 485

(see ① on connection drawing)

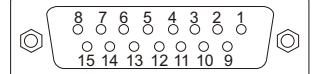

Pin #	Description
1	NC *
2	NC *
3	NC *
4	B - (RS 485)
5	A + (RS 485)
6	NC *
7	NC *
8	NC *
9	RX (RS 232)
10	NC *
11	TX (RS 232)
12	NC *
13	NC *
14	NC *
15	GND (RS 232)

⚠ CAUTION :
NC * --> DO NOT CONNECT

Digital communication

RS 232 communication



• Via RS 232 connection, THA 300 can display 1 or 2 parameters which are measured by other KIMO Class 200 and 300 transmitters.

Benefit : THA 300 can display (in addition to humidity and temperature) other parameters such as pressure, air velocity or airflow from a CP 200 for example.

• Via RS 232 connection, you can also configure your transmitter with the LCC-300 software.

• RS 232 connection cable is available in 2 m, 5 m or 10 m (max) lengths.

Modbus network (RS 485 system)

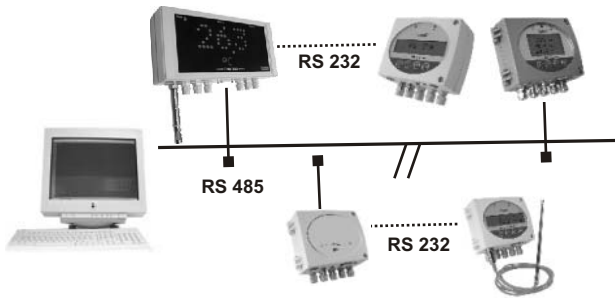

• Via THA 300, you can set up a network of transmitters/displays, on a RS 485 home bus (new or existing network).

• When a Class 200 or 300 transmitter is connected to THA 300 (via RS 232), all the measurements can be sent to the PLC/BMS via the RS 485, with only one address.

• RS 485 digital communication is a 2-wire network, on which the transmitters are connected in parallel. They are connected to a PLC/BMS via the RTU Modbus communication system. In the same way as THA 300 is configured with remote control, Modbus system enables to configure at distance : activate/deactivate a channel, set the measuring range of analogue outputs.

Configuration

You can configure all the parameters : units, measuring ranges, alarms, outputs, channels ... via the different methods shown below :

Via remote control (optional)

This is convenient in order to configure the transmitters located far from the user or hard to reach. Same way as with a keypad (see user manual).

Via software (optional)

Simple and user-friendly configuration. See LCC-300 user manual.

Via Modbus (optional)

Configuration of all parameters from your PC, via the supervision or data acquisition software.

Configurable analogue outputs

Configure the range according to your needs : outputs are automatically adjusted to the new measuring range.

Range with centre zero (-40/0/+40°C), with offset zero (-30/0/+70°C), or standard range (0 /+100°C) => you can configure your own intermediate ranges according to your needs, between 10% and 100% of the full scale.

The minimum configurable range is 10% of the full scale.

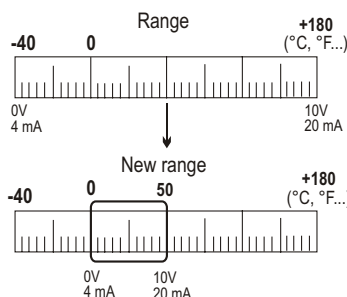

Calibration

On-site adjusting and calibration :

EHK 500 is a reference portable instrument which enables you to adjust at one point THA 300, by correcting any offset whilst measuring in a single ambient environment, housing both sensing elements. You can also adjust at several points.



Output diagnostics :



With this function, you can check with a multimeter (or a regulator/display, or a PLC/BMS) if the transmitter outputs work properly. The transmitter generates a voltage of 0 V, 5 V and 10 V or a current of 4 mA, 12 mA and 20 mA.

Certificate :

• Class 300 transmitters are supplied with adjusting certificates. Calibration certificate are offered as an option.
• Smart-Pro humidity probes are supplied with adjusting certificates and can also be supplied with calibration certificates offered as an option.

Mounting

With the 2 screws, install the mounting bracket in horizontal position along a plane wall (see below dimensions / drilling drawing).

Put the display inside the mounting bracket, with the 2 screws. Remove the screw covers located on the right and left side of housing, in order to have access to the 4 shutting screws.

Make the electrical connection with the connection glands, with soft cable Ø 7 mm maximum. Close the housing before powering on.

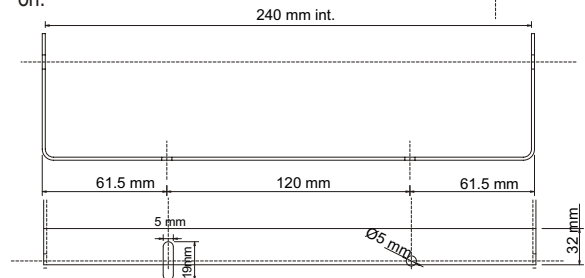
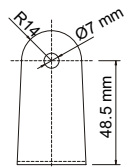

Maintenance

Avoid aggressive solvents.

Protect the transmitter and probes from any cleaning product containing formol, which may be used for cleaning rooms or ducts.

Options

- RS 485 digital output for Modbus protocol
- LCC 300 configuration software with RS 232 cable
- Infrared remote control for configuration
- Calibration certificate.



Optional accessories

- EHK 500 reference portable
- Wall-mounting plate for instrument
- Mounting brackets
- Sliding fittings
- Connection fittings
- Protection tips
- Caps for tips
- Infrared remote control for configuration
- Humidity remote probe.



EXPORT DEPARTMENT

Tel : + 33. 1. 60. 06. 69. 25 - Fax : + 33. 1. 60. 06. 69. 29
site : www.kimo.fr e-mail : export@kimo.fr



Distributed by :